

Article number: 20194B50B502SW

Description: E+G

T-angel clamps GN194-B50-B50-2-SW

## Measures

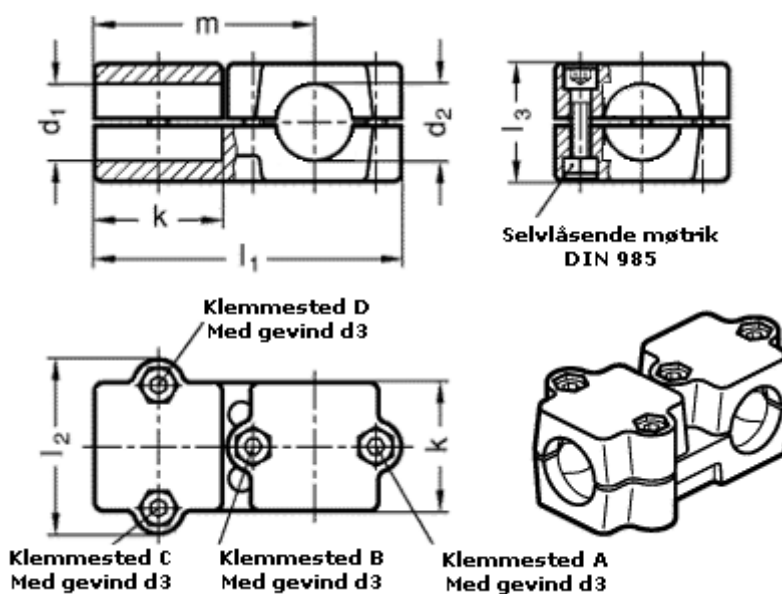

d1 = 50  
d2 = 50  
d3 = M10  
k = 76  
l1 = 176  
l2 = 98  
l3 = 70  
m = 126